

Jacob Head/Foot Board (W4778) - Assembly and Operation Manual

Congratulations on purchasing this product. This product will provide many years of service if you adhere to the following guidelines for assembly, maintenance and operation. This product is for residential use only. Any institutional use is strictly prohibited.

Please be sure to follow the instructions for proper assembly. Use a Phillips head screwdriver for assembling the product in addition to the Allen wrench included in the hardware box. Do not use power screwdrivers. All of our products are made from natural woods. Please understand that natural woods have color variations which are the result of nature and not defects in workmanship.

DO NOT SUBSTITUTE PARTS. ALL MODELS HAVE THE SAME QUANTITY OF PARTS AND HARDWARE. YOUR MODEL MAY LOOK DIFFERENT FROM THE ONE ILLUSTRATED DUE TO STYLISTIC VARIATIONS.

PARTS

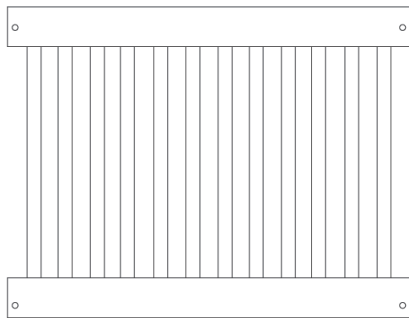

A. Headboard

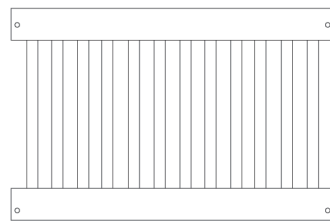

B. Footboard



D. Cross bar (2)



E. Front left Leg



F. Front right leg



G. Rear left Leg



H. Rear right leg

HARDWARE

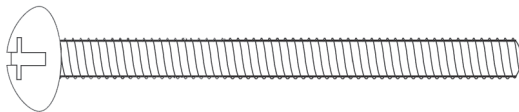

M. 2 1/2" Phillips head bolt (12)



K. Barrel nut (12)

Tools Needed
(not included)

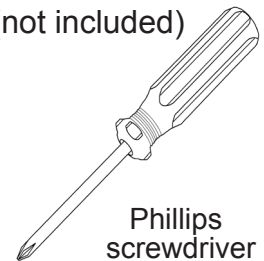

Phillips
screwdriver

STEP 1.

Attach the right (H) and left (G) rear legs to the headboard (A) and cross bar (D) using 6 Phillips head bolts (M) and barrel nuts (K).

Attach the right (F) and left (E) front legs to the footboard (B) and cross bar (D) using 6 Phillips head bolts (M) and barrel nuts (K).

Tighten the bolts securely.

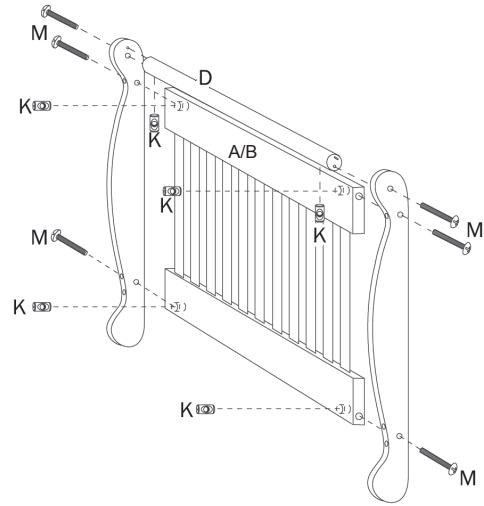

Conversion Rails (W4799-Sold Separately) Assembly Instructions

****Please contact a retailer to order your full size adult wooden bed rails for your full size bed conversion.**

Congratulations on purchasing this product. This product will provide many years of service if you adhere to the following guidelines for assembly, maintenance and operation. This product is for residential use only. Any institutional use is strictly prohibited.

Please be sure to follow the instructions for proper assembly. Use a Phillips head screwdriver for assembling the product in addition to the Allen wrench included in the hardware box. Do not use power screwdrivers. All of our products are made from natural woods. Please understand that natural woods have color variations which are the result of nature and not defects in workmanship.

DO NOT SUBSTITUTE PARTS. ALL MODELS HAVE THE SAME QUANTITY OF PARTS AND HARDWARE. YOUR MODEL MAY LOOK DIFFERENT FROM THE ONE ILLUSTRATED DUE TO STYLISTIC VARIATIONS.

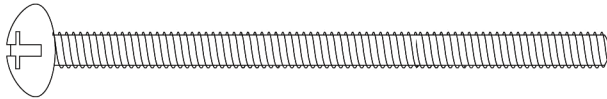

3" Machine Bolts (8 pieces)



Barrel Nuts (8 pieces)

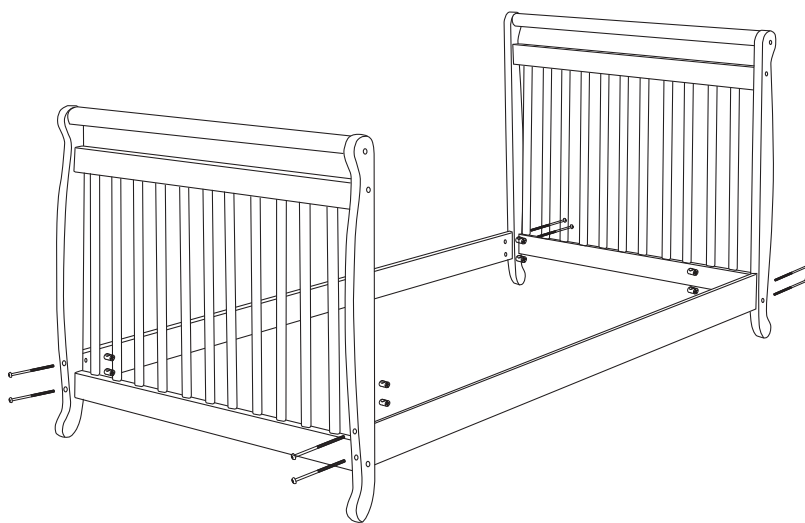

STEP 1.

Insert barrel nuts into bed rails. Use 3" Phillips head bolts to attach the rails. Tighten bolts securely with a Phillips screwdriver.

Be sure to keep the extra bolts and barrel nuts for future use.

**KEEP THIS MANUAL IN A
SAFE PLACE FOR
FUTURE REFERENCE.**

**READ ALL INSTRUCTIONS BEFORE ASSEMBLING THE
PRODUCT. KEEP THE MANUAL FOR FUTURE USE.**

**Please read the Caution and Warning
Statements insert before using your product.**